

532nm Nd:YAG q-switched picosecond laser MD Microchip laser system



DESCRIPTION

532nm laser is one of the most common lasers used in most fields. It can emit excellent green light. It is based on Nd:YAG crystal. Frequency doubling technology is used in Crylink's 532nm laser. As a perfect picosecond laser, our 532nm laser has version of 300ps.

Like our all lasers, 532nm laser has very pure pulsed output. Thus, stability and high quality have become synonymous with our 532nm laser. Good penetrability and strong anti-interference of stray light makes our 532nm laser can adapt most situations.

532nm laser is commonly used in industrial field, like laser engraving and etching to print circuit boards, micro-machining, and so on. Medical field is another common field for 532nm laser. Our 532nm laser is suitable for yag laser eye surgery. Laser ultrasound, laser induced fluorescence, solid state lidar, and et al, are also its competent field.

FEATURES

- Pulse width up to 550ps
- Pulse energy up to 120μJ
- High polarization direction stability
- Maximum repetition rate up to 10kHz
- Beam mode is TEM₀₀
- Fully sealed design, high reliability

APPLICATIONS

- Seed source
- Micromachining
- Fluorescence lifetime measurement
- Laser-induced fluorescence
- Laser ionization mass spectrometry
- Non-linear optical measurement

OUTLINE SIZE(mm)

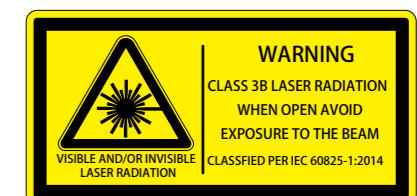
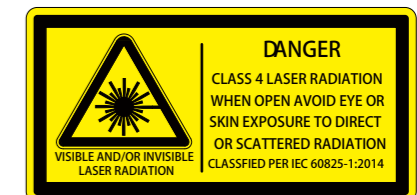
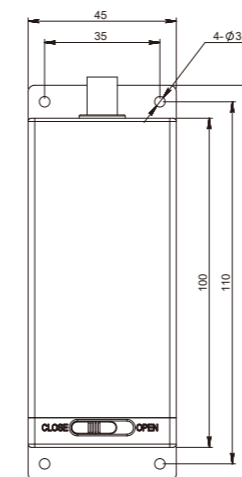
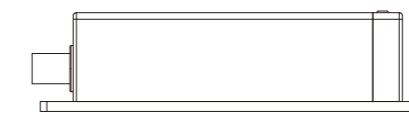
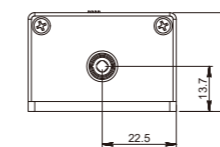
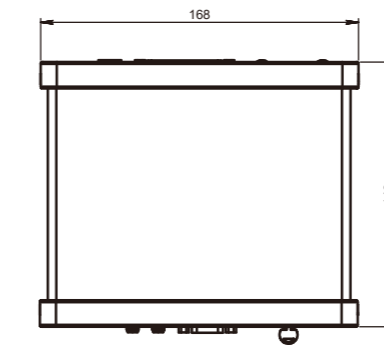
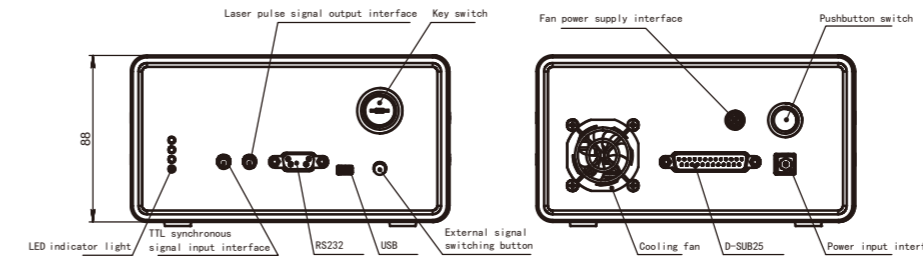

PARAMETERS

Model	CL532-0.1kHz-30μJ-MD003	
Optical parameter	Wavelength (nm)	532
	Repetition frequency (kHz)	0.1
	Average power (mW)	3
	Output energy (μJ)	30
	Pulse width (ps)	300
	Power stability (8h)	±3%
	Beam mode	TEM ₀₀
	Full-angle divergence angle Typ. (Mrad) level @1/e ²	10
	Vertical @1/e ²	10
	Polarization characteristics	> 100:1
System parameters	System power consumption (W)	≤25
	Power input	100-240 VAC,50/60Hz
	Control interface	RS232、USB
	Power supply size (W×H×L, mm)	168×88×140
	Laser head size (W×H×L, mm)	45×30×120
	Working temperature (°C)	15-35
	Storage temperature (°C)	0-60

- *The light outlet of the laser head is side outlet. See the mechanical dimension drawing for details
- Customized internal beam expansion function to meet the requirements of small divergence angle (less than 2mrad)

