

355nm Nd:YAG q-switched picosecond laser MO Microchip laser system

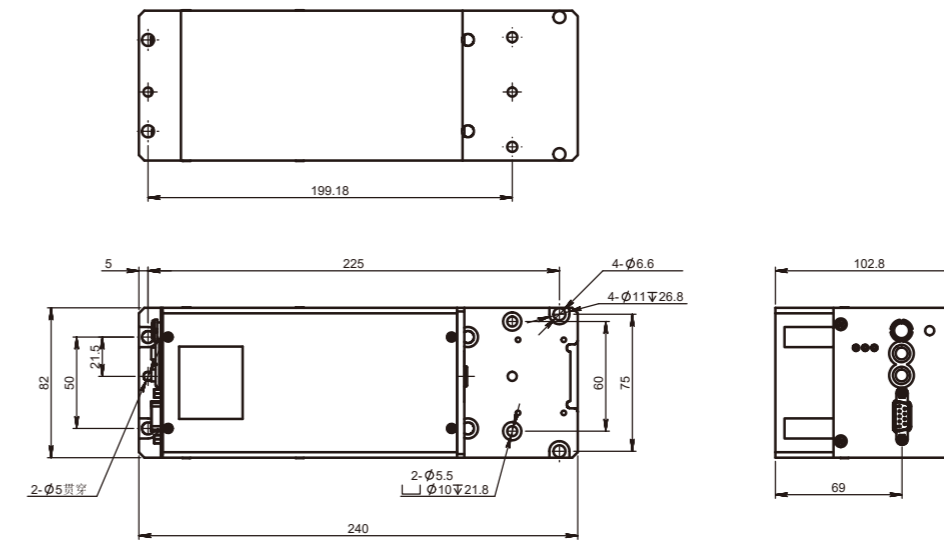

OUTLINE SIZE(mm)



Space output size diagram

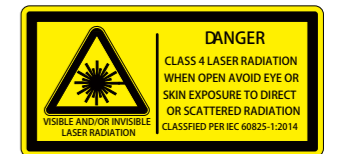

DESCRIPTION

Our 355nm laser is based on the technology of diode pump laser module and q-switch. Nd:YAG crystal is used to manufacture 355nm laser. Crylink can provide 1.5ns, 1ns, 500ps, 550ps and 300ps 355nm microchip laser.

Our 355nm microchip laser has narrow laser pulse width. At the same time, it has high pulse repetition frequency. As a microchip laser, its size is small and its weight is light certainly. Our laser's beam quality is excellent.

As a uv laser, 355nm microchip laser plays an important role in many fields. It can be used in environment monitoring systems, 3d dental scan, laser ultrasound, laser ionization mass spectrometry and so on.

FEATURES

- Maximum repetition rate up to 100kHz
- Pulse width up to 500ps
- Pulse energy up to 5μJ
- Single longitudinal mode
- Beam mode is TEM₀₀
- High polarization direction stability

APPLICATIONS

- Laser processing
- Seed source
- Analysis instrument
- Bioluminescent molecule

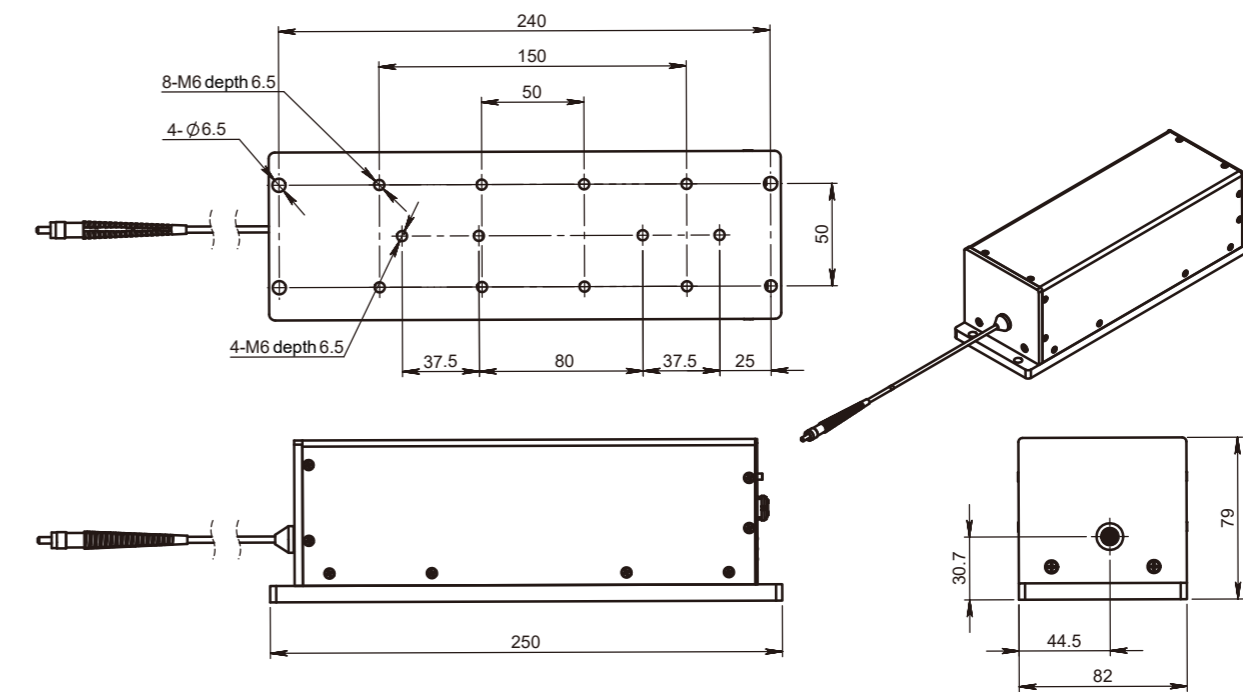

Optical fiber output size diagram



PARAMETERS

Model	CL355-200Hz-25/20μJ-MO002	
Optical parameter	Wavelength (nm)	355
	Repetition frequency (Hz)	1-200
	Maximum output energy of space beam (μJ)	25
	Fiber Coupling Maximum Output Energy (μJ)	20
	Pulse width (ns)	≤1
	Energy Stability(rms)	≤3%
	Energy Regulation Step Accuracy	≤2%
	Beam mode (spatial beam output)	TEM ₀₀
	Full-angle divergence angle Typ. (Mrad) level @1/e ²	≤2
	Vertical @1/e ²	≤2
System parameters	Polarization characteristics	≥100:1
	Fiber parameters (fiber coupled output optional)	200μm/0.22NA
	Power input	24V DC
	Modulation input	TTL0-5V,SMB connector
	Control interface	RS232
	System Peak Power Consumption (W)	< 20
	System Average Power Consumption (W)	< 10
	Laser size (W × H × L, mm)	82×102.8×240(space)/ 82x79x250(optical fiber)
	Working temperature (°C)	10-40
	Storage temperature (°C)	0-60

1. The supported operating frequency is 16~200Hz in continuous mode and burst mode.
2. Fiber core diameter: 200μm.
3. The power supply adapter is shipped with matching power supply, which can support 90~260VAC power supply input.

