

Faraday Rotator



DESCRIPTION

Faraday rotator is a kind of magneto-optical device based on the Faraday magneto-optical effect. When the beam enters forward, the Faraday rotator rotates the linearly polarized light θ , After this beam of light is reflected into the Faraday rotator, the polarization direction of the light is rotated again, and the rotation direction is the same as that of the light entering in the forward direction. At this time, the polarization direction of the outgoing light is rotated by 2 relative to the incident light θ , This can effectively reduce the interference effect between incident light and reflected light, to reduce the impact on the system. Faraday rotators are widely used in various laser systems, such as erbium-doped fiber amplifiers, optical switches, optical modulators, etc., which can effectively avoid optical damage or system instability caused by harmful reflected light.

FEATURES

- High isolation
- Low insertion loss
- Multiple transparent holes
- Multi wavelength available
- Controllable output polarization

APPLICATIONS

- Film locked laser
- Semiconductor laser
- Optical measuring equipment
- Optical parametric oscillator
- Seed light amplification laser



Faraday Rotator

PARAMETER

Model	Central Wavelength	Clear Aperture	Rotation angle @25°C	Extinction ratio @25°C	Transmissivity @25°C	Damage threshold @10ns	Package type
CL-ROT-532-5	532nm	5mm	45°±1°	> 30dB	> 95%	3.5J/cm ²	2#
CL-ROT-633-2.5	633nm	2.5mm	45°±1°	> 30dB	> 95%	3.5J/cm ²	1#
CL-ROT-633-5	633nm	5mm	45°±1°	> 30dB	> 95%	3.5J/cm ²	2#
CL-ROT-780-2.5	780nm	2.5mm	45°±1°	> 30dB	> 95%	3.5J/cm ²	1#
CL-ROT-780-5	780nm	5mm	45°±1°	> 30dB	> 95%	3.5J/cm ²	2#
CL-ROT-785-2.5	785nm	2.5mm	45°±1°	> 30dB	> 95%	3.5J/cm ²	1#
CL-ROT-785-5	785nm	5mm	45°±1°	> 30dB	> 95%	3.5J/cm ²	2#
CL-ROT-1030-2.5	1030nm	2.5mm	45°±1°	> 30dB	> 95%	5J/cm ²	3#
CL-ROT-1030-5	1030nm	5mm	45°±1°	> 30dB	> 95%	5J/cm ²	3#
CL-ROT-1064-2.5	1064nm	2.5mm	45°±1°	> 30dB	> 95%	5J/cm ²	3#
CL-ROT-1064-5	1064nm	5mm	45°±1°	> 30dB	> 95%	5J/cm ²	3#



Faraday Rotator

STRUCTURE DIAGRAM

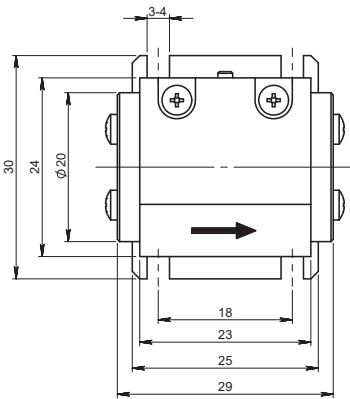

1# Package optical rotator

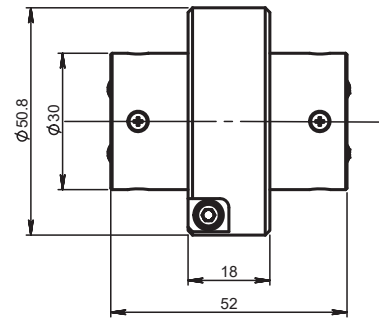
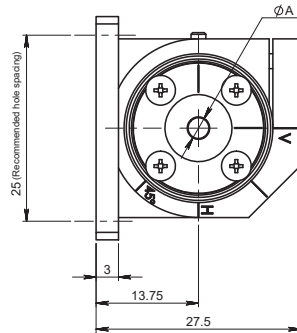

2# Package optical rotator (standard adapter)

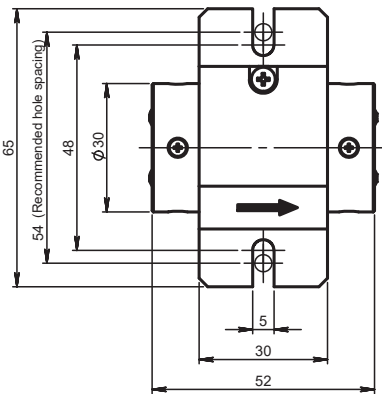
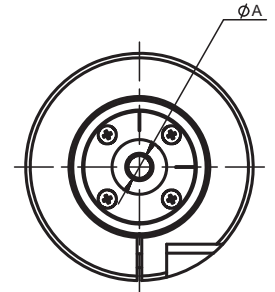

2# Package optical rotator (optional fixed base)

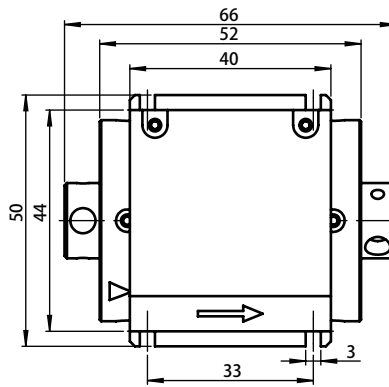
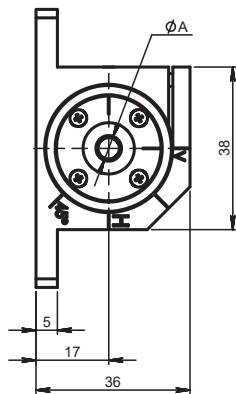

3# Package optical rotator

