

355nm Nd:YAG q-switched nanosecond laser MA Microchip laser system



DESCRIPTION

Our 355nm laser is based on the technology of diode pump laser module and q-switch. Nd:YAG crystal is used to manufacture 355nm laser. Crylink can provide 1.5ns, 1ns, 500ps, 550ps and 300ps 355nm microchip laser.

Our 355nm microchip laser has narrow laser pulse width. At the same time, it has high pulse repetition frequency. As a microchip laser, its size is small and its weight is light certainly. Our laser's beam quality is excellent.

As a uv laser, 355nm microchip laser plays an important role in many fields. It can be used in environment monitoring systems, 3d dental scan, laser ultrasound, laser ionization mass spectrometry and so on.

FEATURES

- Pulse width up to 1ns
- Pulse energy up to 200μJ
- Repetition frequency up to 20kHz
- Beam mode is TEM₀₀
- Fully sealed design, high reliability

APPLICATIONS

- Lidar
- Laser ranging
- Atmospheric monitoring
- Laser ultrasonic inspection
- Optical metrology
- Laser-induced fluorescence

OUTLINE SIZE(mm)

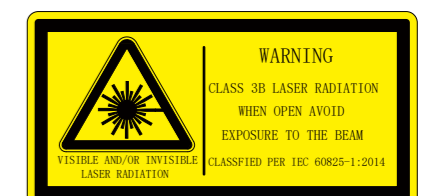
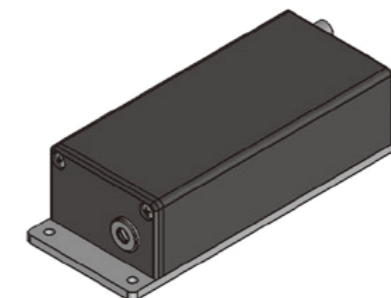
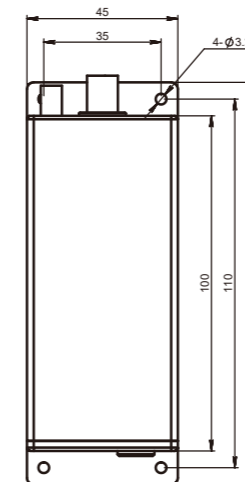
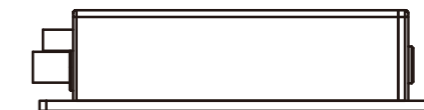
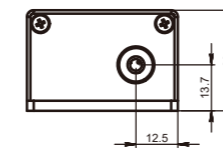
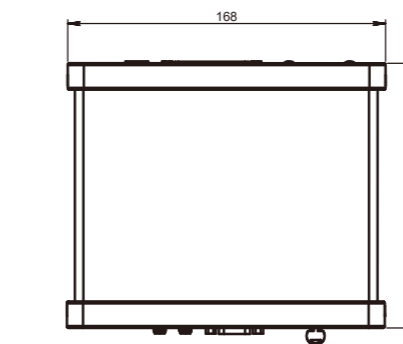
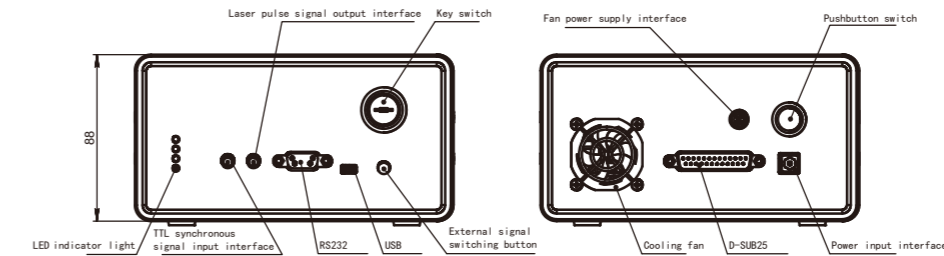

PARAMETERS

Model	CL355-1KHz-30μJ-MA005	CL355-5KHz-10μJ-MA006	CL355-10KHz-5μJ-MA007	CL355-20KHz-3μJ-MA008
Wavelength(nm)	355	355	355	355
Repetition frequency (KHz)	1*	5*	10*	20*
Average power(mW)	30	50	50	60
Output energy(uJ)	30	10	5	3
Pulse width (ps)	1500	1200	1200	1200
Power stability (8h)	±3%	±3%	±3%	±3%
Beam mode	TEM ₀₀	TEM ₀₀	TEM ₀₀	TEM ₀₀
Full-angle divergence angle Typ. (Mrad) level @1/e ²	5	5	5	5
Vertical @1/e ²	5	5	5	5
Polarization characteristics	> 100:1	> 100:1	> 100:1	> 100:1
System power consumption (W)	≤35	≤35	≤35	≤35
Power input	100-240 VAC,50/60Hz	100-240 VAC,50/60Hz	100-240 VAC,50/60Hz	100-240 VAC,50/60Hz
Control interface	RS232、USB	RS232、USB	RS232、USB	RS232、USB
Power supply size (W×H×L, mm)	168×88×140	168×88×140	168×88×140	168×88×140
Laser head size (W×H×L, mm)	45×30×120	45×30×120	45×30×120	45×30×120
Working temperature (°C)	15-35	15-35	15-35	15-35
Storage temperature (°C)	0-60	0-60	0-60	0-60

1.*The light outlet of the laser head is side outlet. See the mechanical dimension drawing for details

2.Customized internal beam expansion function to meet the requirements of small divergence angle (less than 2mrad)

